

Vicair® Vector O2 ORDER FORM

HCPCS CODING: E2624/E2625
ADJUSTABLE SKIN PROTECTION & POSITIONING

permobil

SEATING + POSITIONING



Vector O2

Company Name/ACCT #: _____

P.O. Number: _____

Requested By: _____

Phone: _____ Fax: _____

Email: _____

Ship To: _____

User Reference: _____

For best results, do not fill out in your browser. Interactive form should be completed using Adobe Reader after saving to your local drive. Then email or print and fax to Customer Support at orders.comfort@permobil.com or 1.406.522.8563.

DO NOT SEND PROTECTED HEALTH INFORMATION. IT IS NOT NEEDED TO MAKE THE PRODUCT YOU ARE REQUESTING.

1 SIZE & STYLE

INCOTEC
FOR FLUID PROTECTION &
AN EASILY CLEANED SURFACE.

OR

COMFAIR
FOR USER COMFORT
& HEAT DISSIPATION.

Choose the fabric type and size for the Vector O2 Standard Profile. If a Kwik Strap is needed, choose a size on page 2.

VECTOR O2

HCPCS CODE: E2624/E2625

 = Nonstock items available at extended lead times and a \$40.00 upcharge

		INCOTEC										
		\$476.00					\$525.00					
DEPTH	22"					OVRs-CI-1822	OVRs-CI-1922	OVRs-CI-2022	OVRs-CI-2222	OVRs-CI-2422		
	21"						OVRs-CI-1921					
	20"			OVRs-CI-1620	OVRs-CI-1720	OVRs-CI-1820	OVRs-CI-1920	OVRs-CI-2020	OVRs-CI-2220	OVRs-CI-2420		
	19"			OVRs-CI-1619	OVRs-CI-1719	OVRs-CI-1819	OVRs-CI-1919	OVRs-CI-2019				
	18"	OVRs-CI-1418	OVRs-CI-1518	OVRs-CI-1618	OVRs-CI-1718	OVRs-CI-1818	OVRs-CI-1918	OVRs-CI-2018	OVRs-CI-2218	OVRs-CI-2418		
	17"			OVRs-CI-1617	OVRs-CI-1717	OVRs-CI-1817		OVRs-CI-2017				
	16"	OVRs-CI-1416	OVRs-CI-1516	OVRs-CI-1616	OVRs-CI-1716	OVRs-CI-1816		OVRs-CI-2016				
	15"		OVRs-CI-1515	OVRs-CI-1615								
	14"	OVRs-CI-1414										
		14"	15"	16"	17"	18"	19"	20"	22"	24"		
		WIDTH										

		COMFAIR										
		\$476.00					\$525.00					
DEPTH	22"					OVRs-CC-1822	OVRs-CC-1922	OVRs-CC-2022	OVRs-CC-2222	OVRs-CC-2422		
	21"						OVRs-CC-1921					
	20"			OVRs-CC-1620	OVRs-CC-1720	OVRs-CC-1820	OVRs-CC-1920	OVRs-CC-2020	OVRs-CC-2220	OVRs-CC-2420		
	19"			OVRs-CC-1619	OVRs-CC-1719	OVRs-CC-1819	OVRs-CC-1919	OVRs-CC-2019				
	18"	OVRs-CC-1418	OVRs-CC-1518	OVRs-CC-1618	OVRs-CC-1718	OVRs-CC-1818	OVRs-CC-1918	OVRs-CC-2018	OVRs-CC-2218	OVRs-CC-2418		
	17"			OVRs-CC-1617	OVRs-CC-1717	OVRs-CC-1817		OVRs-CC-2017				
	16"	OVRs-CC-1416	OVRs-CC-1516	OVRs-CC-1616	OVRs-CC-1716	OVRs-CC-1816		OVRs-CC-2016				
	15"		OVRs-CC-1515	OVRs-CC-1615								
	14"	OVRs-CC-1414										
		14"	15"	16"	17"	18"	19"	20"	22"	24"		
		WIDTH										

QUESTIONS? PLEASE CONTACT CUSTOMER SUPPORT FOR ASSISTANCE. | 800.736.0925

Choose the size needed for the Vector O2 with Kwik Strap. If no Kwik Strap is needed, choose a size and fabric for Vector O2 Standard Profile on page 1.

VECTOR O2 WITH KWIK STRAP

		INCOTEC				
		\$486.00			\$535.00	
DEPTH	20"	OVRS-CI-1620-KS	OVRS-CI-1820-KS	OADS-CI-2020-KS	OVRS-CI-2220-KS	OVRS-CI-2420-KS
	18"	OVRS-CI-1618-KS	OVRS-CI-1818-KS	OADS-CI-2018-KS	OVRS-CI-2218-KS	OVRS-CI-2418-KS
	16"	OVRS-CI-1616-KS	OVRS-CI-1816-KS	OADS-CI-2016-KS		
		16"	18"	20"	22"	24"
		WIDTH				

2 VECTOR O2 ACCESSORIES

2.1

REMOVABLE SOLID SEAT PAN & HARDWARE KIT

HCPCS Code: E2231 MSRP \$387.00

The solid seat pan kit includes a slotted aluminum pan and attaching hardware to accommodate 7/8" or 1" tubing. The kit also comes with two different cross bars to accommodate various wheelchair frame types. This will fit both folding and non-folding seat rails. Lateral thigh support hardware can be easily attached.

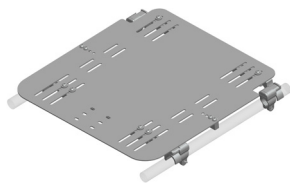

Solid Seat Pan & Hardware Kit (RSSP-N-HARD)

2.2

EXTRA VICAIR® AIR CELLS

MSRP \$43.00 / 50 air cell pack



Pack of 50 Vicair® Air Cells (AIRCELL50)

3 BODILINK® LATERAL PELVIC/THIGH SUPPORT HARDWARE & PADS

Please select sizes in the appropriate fabric & style charts below. Contact Customer Support for custom sizes that are not listed below 800.736.0925.

3.1

PREMIUM PAD SIZE & SHAPE

HCPCS Code: E0953 MSRP \$62.00

- You may make one selection per column (Left, Extra Left, Right, and Extra Right) in section 3.1.
- Make a fabric selection in 3.2.

*Length (L) refers to the actual size dimension of the support from top to bottom edge. Depth (D) refers to the actual size dimension from anterior to posterior edge.

STYLE	SIZE	LEFT	EXTRA LEFT	RIGHT	EXTRA RIGHT
	3.5" L x 4" D	BL-LPTSP2Z-3L4D-LH	BL-LPTSP2Z-3L4D-LH	BL-LPTSP2Z-3L4D-RH	BL-LPTSP2Z-3L4D-RH
	3.5" L x 8" D	BL-LPTSP2Z-3L8D-LH	BL-LPTSP2Z-3L8D-LH	BL-LPTSP2Z-3L8D-RH	BL-LPTSP2Z-3L8D-RH
	3.5" L x 12" D	BL-LPTSP2Z-3L12D-LH	BL-LPTSP2Z-3L12D-LH	BL-LPTSP2Z-3L12D-RH	BL-LPTSP2Z-3L12D-RH
	5.5" L x 6" D	BL-LPTSP2Z-5L6D-LH	BL-LPTSP2Z-5L6D-LH	BL-LPTSP2Z-5L6D-RH	BL-LPTSP2Z-5L6D-RH

3.2 PREMIUM PAD COVER WITH FOAM INSERT

COVER OPTIONS	MSRP	LEFT		EXTRA LEFT		RIGHT		EXTRA RIGHT	
COMFORT-TEK®	\$0.00/ea.		LPTS-P2-COMFORT-FM		LPTS-P2-COMFORT-FM		LPTS-P2-COMFORT-FM		LPTS-P2-COMFORT-FM
STRETCH-AIR®	\$0.00/ea.		LPTS-P2-STRETCH-FM		LPTS-P2-STRETCH-FM		LPTS-P2-STRETCH-FM		LPTS-P2-STRETCH-FM
GLIDEWEAR®	\$13.00/ea.		LPTS-P2-GLIDE-FM		LPTS-P2-GLIDE-FM		LPTS-P2-GLIDE-FM		LPTS-P2-GLIDE-FM

COMFORT-TEK®
FOR FLUID PROTECTION & AN EASILY CLEANED SURFACE.

STRETCH-AIR®
FOR USER COMFORT & HEAT DISSIPATION.

GlideWear
FOR SKIN PROTECTION & SHEAR REDUCTION.
NOT FLUID RESISTANT.

• You may make one selection per column (Left, Extra Left, Right, and Extra Right) in section 3.3 from group A, B, or C.
• TT long extension arms (section 3.4) will only work with TT style hardware.

3.3 BODILINK® LATERAL PELVIC/THIGH SUPPORT HARDWARE

A. TT HARDWARE, SLOT MOUNT

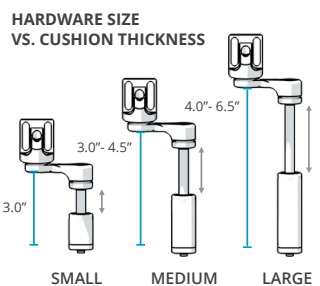
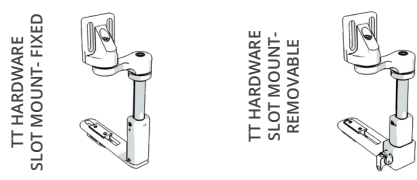

HARDWARE SIZE	MAX CUSHION THICKNESS CLEARANCE	RECOMMENDED CUSHION THICKNESS
SMALL	3.0"	2.0"- 3.0"
MEDIUM	4.5"	3.0"- 4.5"
LARGE	6.5"	4.0"- 6.5"

FIXED	SIZE	MSRP	LEFT		EXTRA LEFT		RIGHT		EXTRA RIGHT	
	SMALL	\$141.00		BL-LPTS-TT1FXSL1-LH		BL-LPTS-TT1FXSL1-LH		BL-LPTS-TT1FXSL1-RH		BL-LPTS-TT1FXSL1-RH
MEDIUM	\$141.00		BL-LPTS-TT1FXSL2-LH		BL-LPTS-TT1FXSL2-LH		BL-LPTS-TT1FXSL2-RH		BL-LPTS-TT1FXSL2-RH	
LARGE	\$141.00		BL-LPTS-TT1FXSL3-LH		BL-LPTS-TT1FXSL3-LH		BL-LPTS-TT1FXSL3-RH		BL-LPTS-TT1FXSL3-RH	
REMOVABLE E1028	SIZE	MSRP	LEFT		EXTRA LEFT		RIGHT		EXTRA RIGHT	
	SMALL	\$248.00		BL-LPTS-TT1RMSL1-LH		BL-LPTS-TT1RMSL1-LH		BL-LPTS-TT1RMSL1-RH		BL-LPTS-TT1RMSL1-RH
	MEDIUM	\$248.00		BL-LPTS-TT1RMSL2-LH		BL-LPTS-TT1RMSL2-LH		BL-LPTS-TT1RMSL2-RH		BL-LPTS-TT1RMSL2-RH
LARGE	\$248.00		BL-LPTS-TT1RMSL3-LH		BL-LPTS-TT1RMSL3-LH		BL-LPTS-TT1RMSL3-RH		BL-LPTS-TT1RMSL3-RH	

B. TT HARDWARE, POWER MOUNT

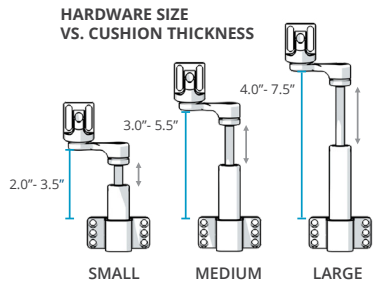
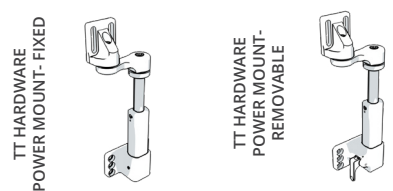

HARDWARE SIZE	MAX CUSHION THICKNESS CLEARANCE	RECOMMENDED CUSHION THICKNESS
SMALL	3.5"	2.0"- 3.5"
MEDIUM	5.5"	3.0"- 5.5"
LARGE	7.5"	4.0"- 7.5"

FIXED	SIZE	MSRP	LEFT		EXTRA LEFT		RIGHT		EXTRA RIGHT	
	SMALL	\$185.00		BL-LPTS-TT1FXPWL1-LH		BL-LPTS-TT1FXPWL1-LH		BL-LPTS-TT1FXPWL1-RH		BL-LPTS-TT1FXPWL1-RH
	MEDIUM	\$185.00		BL-LPTS-TT1FXPWL2-LH		BL-LPTS-TT1FXPWL2-LH		BL-LPTS-TT1FXPWL2-RH		BL-LPTS-TT1FXPWL2-RH
LARGE	\$185.00		BL-LPTS-TT1FXPWL3-LH		BL-LPTS-TT1FXPWL3-LH		BL-LPTS-TT1FXPWL3-RH		BL-LPTS-TT1FXPWL3-RH	
REMOVABLE E1028	SIZE	MSRP	LEFT		EXTRA LEFT		RIGHT		EXTRA RIGHT	
	SMALL	\$285.00		BL-LPTS-TT1RMPWL1-LH		BL-LPTS-TT1RMPWL1-LH		BL-LPTS-TT1RMPWL1-RH		BL-LPTS-TT1RMPWL1-RH
	MEDIUM	\$285.00		BL-LPTS-TT1RMPWL2-LH		BL-LPTS-TT1RMPWL2-LH		BL-LPTS-TT1RMPWL2-RH		BL-LPTS-TT1RMPWL2-RH
LARGE	\$285.00		BL-LPTS-TT1RMPWL3-LH		BL-LPTS-TT1RMPWL3-LH		BL-LPTS-TT1RMPWL3-RH		BL-LPTS-TT1RMPWL3-RH	

TT HARDWARE, POWER MOUNT OPTION

NOTE: If choosing the Power Mount Hardware, choose the appropriate power mount type below.

POWER MOUNT	MSRP	PART NUMBER
QUANTUM	add \$0.00	LPTS-TT1-PW1
PERMOBIL	add \$0.00	LPTS-TT1-PW2
QUICKIE	add \$0.00	LPTS-TT1-PW3
ROVI	add \$0.00	LPTS-TT1-PW4
AVID REHAB	add \$0.00	LPTS-TT1-PW5

3.4 TT LONG EXTENSION ARM 4" MSRP \$37.00/arm

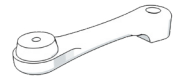

LEFT	EXTRA LEFT	RIGHT	EXTRA RIGHT
BL-LPTS-TT1LARM4	BL-LPTS-TT1LARM4	BL-LPTS-TT1LARM4	BL-LPTS-TT1LARM4

4 BODILINK® MEDIAL KNEE/THIGH SUPPORT HARDWARE & PADS

- You may make one selection per column.
- Choose between wedge or oval in 4.1.
- Choose a cover material in 4.2.
- Choose hardware size in 4.3.

4.1 PAD SIZE & SHAPE

HCPCS CODING: E0957 MSRP \$130.00

STYLE	SIZE	PART NUMBER
<p>WEDGE</p>	2.5"W x 3.5"D	BL-MKTSP1-3W4D
	3.5"W x 5"D	BL-MKTSP1-4W5D
	4"W x 6"D	BL-MKTSP1-4W6D
<p>OVAL</p>	2.5"W x 3.5"D	BL-MKTSP2-3W4D
	3.5"W x 5"D	BL-MKTSP2-4W5D
	5"W x 6"D	BL-MKTSP2-5W6D

4.2 PAD COVER MATERIAL

<p>GlideWear INNOVATIVE SKIN PROTECTION</p>	FOR SKIN PROTECTION & SHEAR REDUCTION. NOT FLUID RESISTANT.
<p>COMFORT-TEK</p>	FOR FLUID PROTECTION & AN EASILY CLEANED SURFACE.
<p>STRETCH-AIR</p>	FOR USER COMFORT & HEAT DISSIPATION.

GlideWear® (MKTSP-GLIDE) (add \$15.00)
Comfort-Tek® (MKTSP-COMFORT)
Stretch-Air® (MKTSP-STRETCH)

4.3 MEDIAL KNEE/THIGH SUPPORT SWING AWAY HARDWARE

HCPCS CODING: E1028 MSRP \$180.00

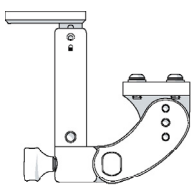

SIZE	PART NUMBER
SMALL	BL-MKTS-ST1SASL1
MEDIUM	BL-MKTS-ST1SASL2
LARGE	BL-MKTS-ST1SASL3

- *Swing Away Hardware only, not available in Fixed Hardware
- **MKTS Hardware must be mounted to Removable Solid Seat Pan in section 2.4
- ***If Leg Length Discrepancy is needed on Removable Solid Seat Pan, Offset Orientation must be selected

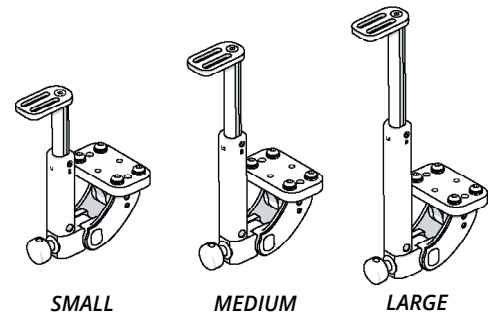
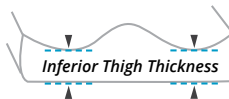

SIZE	RECOMMENDED INFERIOR THIGH THICKNESS
Small	1.00" - 3.00"
Medium	2.00" - 5.00"
Large	3.00" - 7.00"